

No. 5589

**SHERPA<sup>®</sup>** infobase telescope

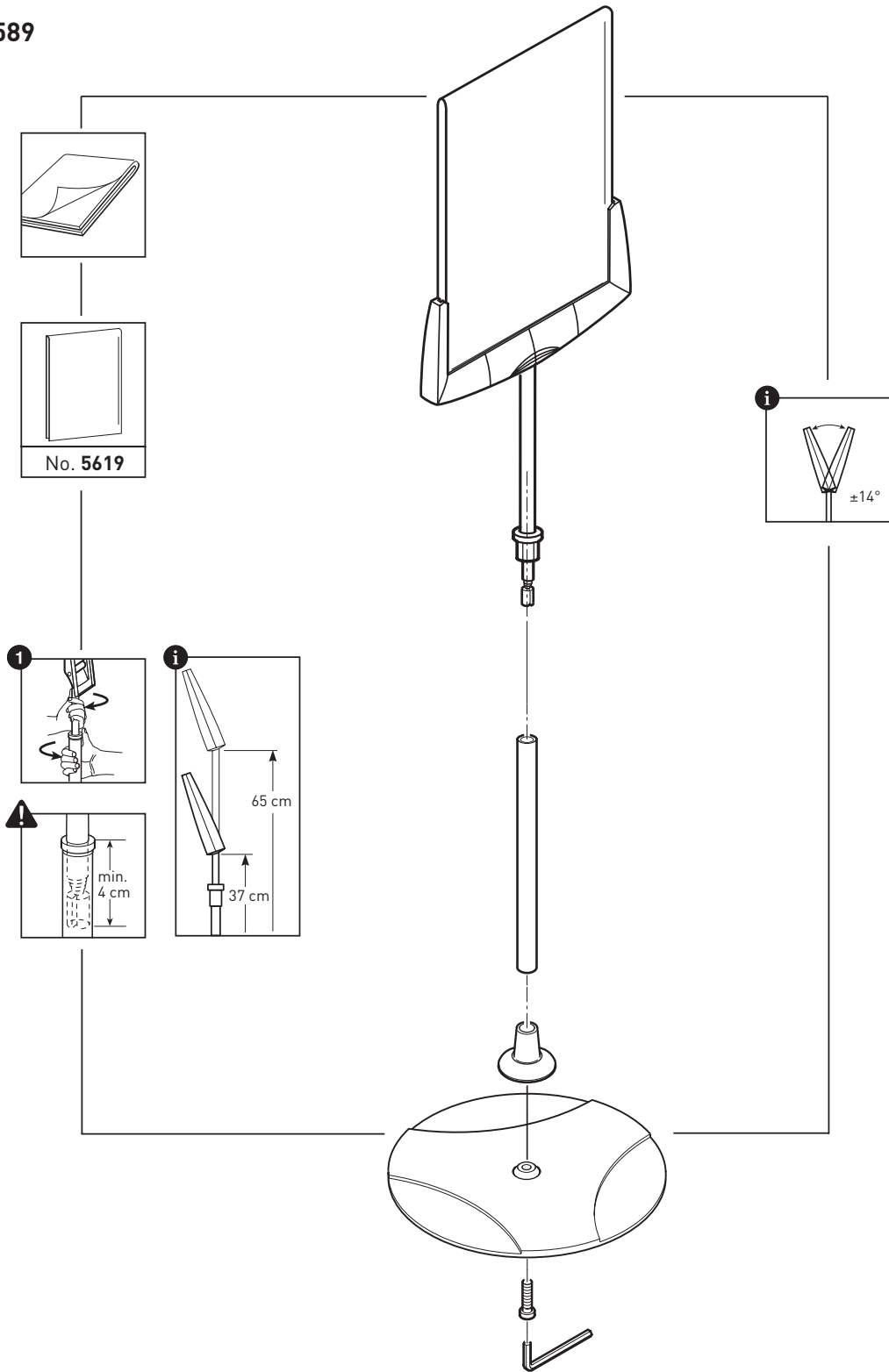

# SHERPA®

Sichttafel-System · Sortimentsauszug  
 Display Panel System · Extract of the range  
 Système de plaques à pochettes · Extrait de la gamme  
 Sistema de fundas transparentes · Extractp de la gama

No. 5606

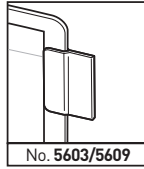
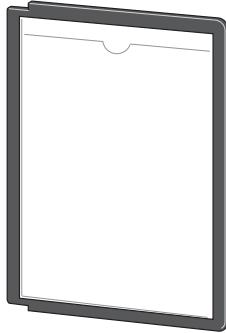

No. 5607

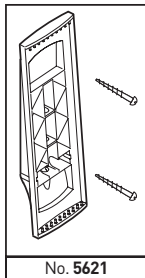
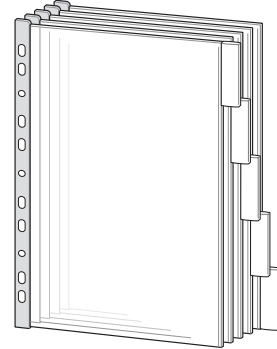

No. 5621

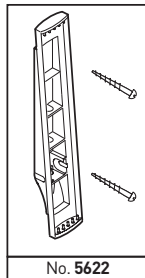

No. 5622

No. 5621

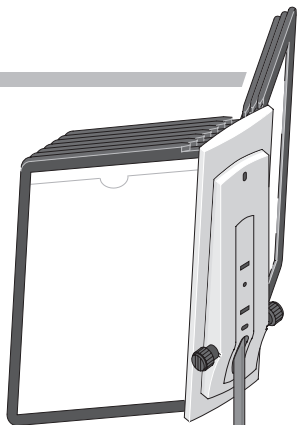
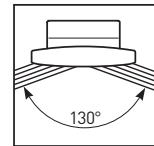
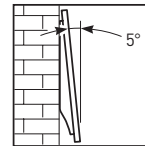
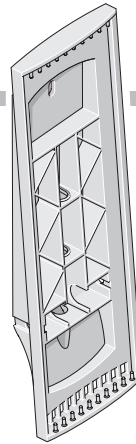

No. 5626

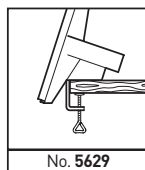
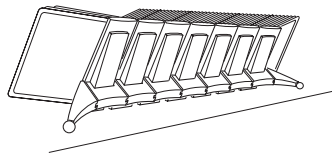

No. 5629

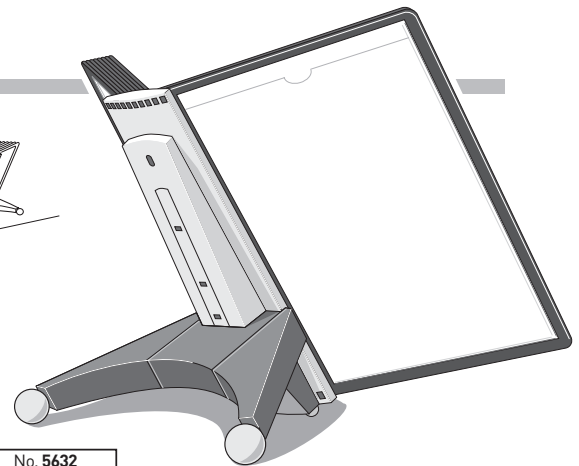

No. 5632

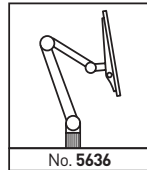
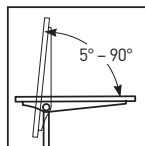

No. 5636

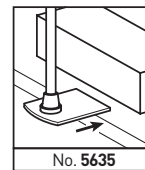

No. 5635

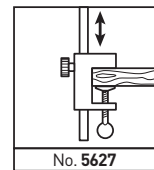

No. 5627

